

High-Performance Deterministic Concurrency using LINGUA FRANCA

Christian Menard
christian.menard@tu-dresden.de
TU Dresden, Germany

Matthew Chorlian
mattchorlian@berkeley.edu
UC Berkeley, USA

Clément Fournier
clement.fournier@tu-dresden.de
TU Dresden, Germany

Tassilo Tanneberger
tassilo.tanneberger@tu-dresden.de
TU Dresden, Germany

Marten Lohstroh
marten@berkeley.edu
UC Berkeley, USA

Arthur Deng
langxing.deng@berkeley.edu
UC Berkeley, USA

Shaokai Lin
shaokai@berkeley.edu
UC Berkeley, USA

Hokeun Kim
hokeun@hanyang.ac.kr
Hanyang University, South Korea

Edward A. Lee
eal@berkeley.edu
UC Berkeley, USA

Soroush Bateni
soroush@berkeley.edu
UC Berkeley, USA

Peter Donovan
peterdonovan@berkeley.edu
UC Berkeley, USA

Felix Suchert
felix.suchert@tu-dresden.de
TU Dresden, Germany

Jeronimo Castrillon
jeronimo.castrillon@tu-dresden.de
TU Dresden, Germany

Abstract

Actor frameworks and similar reactive programming techniques are widely used for building concurrent systems. They promise to be efficient and scale well to a large number of cores or nodes in a distributed system. However, they also expose programmers to nondeterminism, which often makes implementations hard to understand, debug, and test. The recently proposed reactor model is a promising alternative that enables efficient deterministic concurrency. In this paper, we show that determinacy does neither imply a loss in expressivity nor in performance. To show this, we evaluate LINGUA FRANCA (LF), a reactor-oriented coordination language that equips mainstream programming languages with a concurrency model that automatically takes advantage of opportunities to exploit parallelism that do not introduce nondeterminism. Our implementation of the Savina benchmark suite demonstrates that, in terms of execution time, the runtime performance of LF programs even exceeds popular and highly optimized actor frameworks. We compare against Akka and CAF, which LF outperforms by 1.86x and 1.42x, respectively.

CCS Concepts: • Computing methodologies → Concurrent programming languages; • Software and its engineering → Runtime environments; Source code generation.

Keywords: coordination, concurrency, determinism, performance

1 Introduction

Theoreticians working on programming language semantics have long understood the value of determinism as well as the expressive power of nondeterminism in programming languages. In practice, however, today, nondeterminism creeps into programming languages and frameworks not to benefit from its expressiveness, but rather because of a widespread perception that it is needed to get good performance on parallel hardware. We show in this paper that it is not necessary to sacrifice determinism to achieve performance. We do this by focusing on actor frameworks, which have proved popular and successful in many very demanding applications, but admit nondeterminism that is often not actually needed by their applications.

Exploiting parallel hardware such as multicore machines to improve performance is only possible when programs expose concurrency. Common abstractions for concurrency include threads [18], remote procedure calls [63], publish-subscribe [27], service-oriented architectures [64], and actors [1, 33]. Each of these models has its own merits, but they all introduce nondeterminism: situations where, for a given state and input, the behavior of a program is not uniquely defined. While nondeterminism can be useful in some applications, most programming tasks benefit from more repeatable behavior. Deterministic programs are easier to understand, debug, and test (for each test vector, there is one known-good response). For nondeterministic programs, problematic behaviors might be harder to discover because they may only occupy a small fraction of the state space [37]. And reproducing failures can be extremely hard [40, 48, 61]

because they might occur only when the system is under a specific amount of load [67].

Determinism is a subtle concept [41]. Here, we focus on a particular form of determinism for programs, where a program is deterministic if, given the same inputs, it always produces the same outputs. This definition does not require that operations be performed in a particular order, and therefore is not at odds with concurrency and parallel execution. It is possible, but often not easy, to achieve this form of determinism even when using nondeterministic abstractions such as threads, actors, and asynchronous remote procedure calls. For simple enough programs, such as a chain of actors, if communication is reliable, then execution will be deterministic. Some of the benchmarks we compare against in this paper are deterministic in this way. As we will show, however, even slightly more complex communication structures result in nondeterminism that can be difficult to correct.

In this paper, we evaluate a language-based coordination approach to specifying concurrent software that preserves determinism by default and only admits nondeterminism when explicitly introduced by the programmer. The coordination language LINGUA FRANCA (LF) [53], which is based on a concurrent model of computation called reactors [50, 51], achieves this by analyzing program structure and ensuring that data dependencies are observed correctly at runtime. An LF program defines reactive software components called “reactors” and provides operators to compose them hierarchically (through containment) and bilaterally (via connections). Because the language supports both deterministic and nondeterministic concurrency, it provides a fertile ground for exploring the impact of determinism on performance.

The semantics of the deterministic subset of LF can be thought of as a deterministic variant of actors [1, 33, 52]. We show in this paper that it delivers performance comparable to popular nondeterministic realizations of actors on parallel hardware. Like Akka [66] and CAF [16]—the frameworks we compare against—LF orchestrates the execution of chunks of code written in conventional programming languages, allowing programmers to rely on the languages, libraries, and tools that they are comfortable with. Unlike the frameworks we compare against, LF is polyglot. It currently supports C, C++, Python, TypeScript, and Rust. This paper focuses on the runtime performance of the C++ target, which, as a core contribution of this paper, has been optimized to efficiently exploit concurrency on parallel hardware. Earlier work [53] has only reported preliminary performance indications of LF based on its C target, which is predominantly aimed at running on embedded systems.

At the core of LF’s concurrency model is a logical model of time that gives a clear notion of simultaneity and avoids deadlocks using dependency analysis based on causality interfaces [47]. It is this timed semantics that enables efficient deterministic concurrency in LF. However, the benchmarks we compare against were created to evaluate actor frameworks,

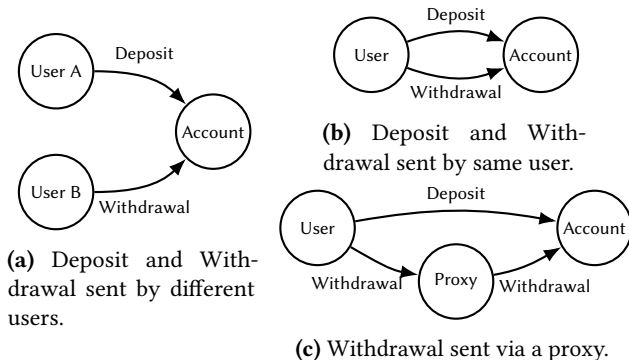

Figure 1. Example actor programs that may expose nondeterministic behavior.

which have no temporal semantics. None of the benchmarks take advantage of the time-related features of LF; the temporal semantics is only used to deliver determinism.

Contributions. We show that the reactor-oriented paradigm as implemented in LINGUA FRANCA enables efficient exploitation of parallel hardware without relinquishing determinism. For this, we explain the mechanisms through which LF programs expose concurrency; we present a language extension that allows for the definition of scalable programs; and we introduce an optimized C++ runtime for LF that enables efficient parallel execution. We further present an extensive evaluation based on the Savina benchmark suite [34], showing that our LF runtime outperforms Akka and CAF by 1.86x and 1.42x, respectively.

Outline. We first motivate our work (Section 2) and then introduce LF (Section 3). We then go into detail about the concurrency in LF and introduce our optimized C++ runtime (Section 4). Next, we report benchmark results (Section 5), discuss related work (Section 6), and conclude (Section 7).

2 Motivation

The actor model is widely accepted and deployed in production for its promise to allow programmers to easily express concurrency, provide high execution performance, and scale well to large datasets and complex applications. Moreover, in contrast to thread-based programs, actor semantics prevents *low-level* data races. However, like most message passing paradigms, actors expose the programmer to nondeterminism in the form of *high-level* data races [76], a problem that becomes considerably challenging to manage as the complexity of a program grows.

Consider the simple example in Figure 1a. The Account actor manages the balance of a bank account that two users interact with. User A sends a deposit message increasing the account’s balance and User B sends a withdrawal message decreasing the account’s balance. If we assume that the

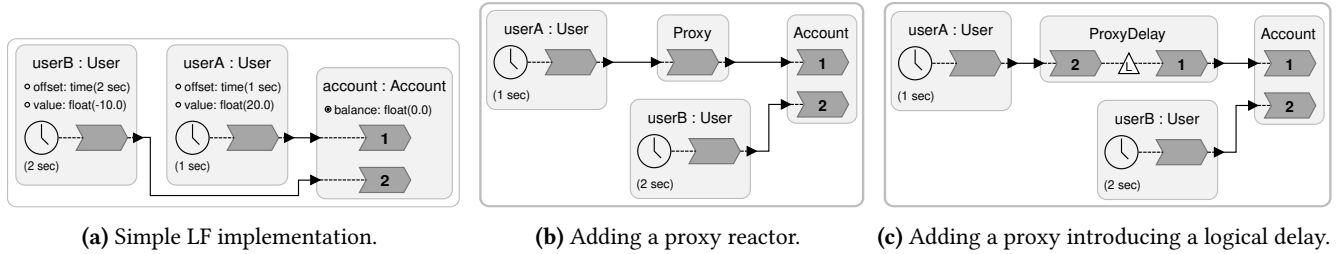

Figure 2. Example LF implementation of the actor program shown in Figure 1a and variations thereof.

balance is initialized to 0 and the account only grants a withdrawal if the resulting balance is not negative, then there are two possible behaviors. If A’s message is processed first, then the withdrawal is granted to B. If B’s message is processed first, then the withdrawal is denied. The actor model assigns no meaning to the ordering of messages. Therefore, there is no well-defined correct behavior for this example.

The reader may object that for an application like that of Figure 1a, the order of transactions is intrinsically nondeterministic, and any additional nondeterminism introduced by the software framework is inconsequential. However, if we focus on testability, we see that even identical inputs can yield different results, making testing more difficult. If we focus on consistency, the problem that different observers of the same events may see different behaviors becomes problematic. In databases, it is common to assign time stamps to external inputs and to then treat those timestamps as a semantic property of the inputs and define the behavior of the database relative to those time stamps. We adopt this perspective in this paper, and rely on the definition of determinism given by Lee [41]: “determinism is a property of models, not of physical realizations,” and “A model is deterministic if given all the *inputs* that are provided to the model, the model defines exactly one possible *behavior*.” If we define “inputs” in Figure 1a to be time-stamped user queries and “behavior” to be the sequence of actions taken by the Account, then it is reasonable to demand determinism.

Consider Figure 1b, which has only one user. Even if this one user first sends a deposit and then a withdrawal message, the actor model does not guarantee that the receiving actor sees and processes the incoming messages in this order. While some actor frameworks, e.g., Akka and Erlang, guarantee in-order message delivery, others, e.g., AmbientTalk [77], expressly do not. Yet, even if the framework guarantees point-to-point in-order message delivery, this property is not transitive. If we add a Proxy, as shown in Figure 1c, then we cannot make any assumptions about the order in which Account receives messages. This example further illustrates that composing actors can have unexpected side effects.

Consequently, implementing solutions to practical concurrency problems with actors can be challenging. Even seemingly simple concurrency problems like the one discussed above require high programming discipline, and solutions are

typically difficult to maintain and tend to lack modularity. In addition, the inherent nondeterminism of actor frameworks makes it hard to verify such solutions. Erroneous behavior might only occur in a fraction of executions, and thus integration tests cannot reliably detect such “Heisenbugs” [61].

In a recent study, Bagherzadeh et al. [4] analyzed bugs in Akka programs that were discussed on StackOverflow or GitHub and determined that 14.6% of the bugs are caused by races. This makes high-level races the second most common cause of bugs in Akka programs after errors in the program logic. In a similar study of 12 actor-based production systems, Hedden and Zhao [32] determined that 3.2% of the reported bugs were caused by bad message ordering, 4.8% of bugs were caused by incorrect coordination mechanisms, 4.8% were caused by erroneous coordination at shutdown, and 2.4% of bugs were caused by erroneous coordination at startup. Note that these numbers only cover *known* bugs in their studied projects and, as noted by the authors, the majority of the reported message ordering bugs belonged to the Gatling project because it already incorporated a debugging tool called Bita [73] that is designed to detect such bugs. We suspect that there are more undetected bugs in projects that do not use specialized debugging tools.

The actor community has addressed the inherent nondeterminism of actors and the resulting bugs by introducing better tools for analyzing and debugging actor programs. This includes TransPDOR [72], Bita [73], Actoverse [69], iDeA [55], CauDEr [39], and Multiverse debugging [75]. While these are valuable solutions, we argue that a programming model for expressing concurrent programs should provide deterministic semantics by default and allow the programmer to introduce nondeterminism only where it is desired and understood to do no harm. In such cases, the aforementioned tools for nondeterministic behavior can still be utilized to debug the implementation.

There are a number of ways to achieve deterministic concurrency, including Kahn process networks [35, 36], many flavors of dataflow models [21, 43, 62], physically asynchronous, logically synchronous models [68], synchronous-reactive languages [8, 24], and discrete-event systems [15, 23, 46, 79]. Lohstroh et al. [53] compare the reactor model to each of these, showing that it has many of their best features and

fewer of their pitfalls. LINGUA FRANCA builds on this reactor model because it is more expressive than some of the alternatives (e.g., Kahn networks) and is stylistically close to actors, which have proven effective in practice. In this paper, we show that the resulting determinism does not incur a performance penalty, but on the contrary, helps to achieve improved performance in most cases.

3 Introduction to LINGUA FRANCA

LINGUA FRANCA (LF) builds on the relatively new reactor-oriented programming paradigm. Intuitively, we can describe reactors as deterministic actors with a discrete event execution semantics and explicitly declared ports and connections. A logical timeline is used to order events and ensure a deterministic execution. As a polyglot language, LF incorporates code in a target programming language to implement the logic of each component. LF itself is only concerned with the coordination aspect of a program.

In this section, we introduce the core concepts of reactors and LF. Note however, that a full discussion of LF including its syntax and tooling is beyond the scope of this paper. Instead, we base our discussion on LF’s diagrammatic representation of programs which gets synthesized from LF source code automatically [78]. A complete introduction to LF’s textual syntax is given by Lohstroh et al. [53].

3.1 LF by Example

Figure 2a shows an LF implementation of the deposit/withdrawal example in Figure 1a. The program is assembled from three **reactor instances** `userA`, `userB` and `account`, shown as light gray boxes in the diagram. Note that `userA` and `userB` are instances of the same **reactor class** `User` and hence share the same structure and functionality. In the diagram, black triangles denote **ports**. In this example, both users have an output port which is connected to a respective input port at the account. These ports and connections allow the users to send requests to the account.

In LF, all computation is performed in reactive code segments called **reactions** that are implemented in an arbitrary target language. In the diagram, reactions are represented by dark gray chevrons. All reactions must explicitly declare their triggers, other dependencies and potential effects. In the example in Figure 2a, both users define a reaction that is triggered by a **timer**. Timers are an LF construct used to produce events in regular intervals or once at a specific time. The timer of `userA` is configured to trigger an event one second after program startup; the timer of `userB` is configured to trigger an event two seconds after program startup. The corresponding reactions simply send a deposit or withdrawal request by setting the user’s output port.

The `Account` reactor defines two reactions, one for each of its inputs. Both reactions will simply try to apply the requested change to the balance, which is stored in a state

variable local to the reactor instance. Note that reactors may define arbitrary state variables which are accessible by all their own reactions (which does not include reactions of contained reaction). In addition to state variables, reactors may also define parameters which can be set at instantiation. This mechanism allows the `User` reactor to be reusable, as the precise time at which the timer triggers (offset) and the amount to withdraw or deposit (value) are configurable at instantiation time.

The reader might notice that the separated reactions in account duplicate logic and are not a practical solution, in particular if there are many users. We choose this representation to keep our exposition simple and avoid a detailed discussion of LF syntax. Indeed, in LF a single reaction can bind to an arbitrary number of upstream ports.

When executed, the program will wait for 1 second before triggering the timer of the `userA` reactor and invoking its reaction. The event produced by this reaction will trigger reaction 1 in `account`, which is invoked immediately after the first reaction completes. Two seconds after program startup, `userB` will react and subsequently trigger reaction 2 in `account`. In this example, the deposit event (+20.0) occurs earlier than the withdrawal event (-10.0), and hence our execution semantics ensures that the account processes the deposit event before the withdrawal event, meaning the balance will not become negative. In a more realistic implementation, the two users would generate events sporadically and have their reactions triggered not by a timer but a physical action (see Section 3.3). However, using a timer greatly simplifies our exposition as we only have to consider a single *logical timeline* along which events are ordered. Moreover, such timers can be used to create regression tests that validate program execution with specific input timings.

Note that even when the two events occur logically simultaneously, meaning that both reactions in the `account` reactor are triggered at the same logical time, the resulting program will be deterministic. All reactions within the same tag are executed according to a well-defined precedence relation. In particular, any reactions within the same reactor are mutually exclusive and executed following the lexical declaration order of the reactions in LF code. This order is also reflected by the numbers displayed on the reactions in the diagrams in Figure 2. More details on the precedence relation of reactions are given in Section 4.1.

To deliberately change the order in which events occur, a logical delay can be introduced in the program using a **logical action**, as shown in Figure 2c. In the diagram, actions are denoted by small white triangles. In contrast to ports, which allow relaying events logically instantaneously from one reactor to another, logical actions provide a mechanism for scheduling new events at a later (logical) time. Upon receiving an input, reaction 2 of the `ProxyDelay` reactor is triggered, which schedules its logical action with a configurable

delay. This creates a new event which, when processed, triggers reaction 1 of the ProxyDelay reactor, which retrieves the original value and forwards it to its output port.

If we assume that a delay of 2 seconds is used for scheduling the logical action, then the deposit message from userA will only arrive at the account 3 seconds after startup. Hence the deposit message will be processed *after* the withdrawal message from userB, causing B’s request to be denied.

It is important to note that all of the discussed examples are deterministic, regardless of the physical execution times of reactions, as all events are unambiguously ordered along a single logical timeline. The physical timing of the events, on the other hand, will be approximate. The contribution of this paper is to show that such determinism does not necessarily reduce performance and is also useful for applications that have no need for explicit timing.

3.2 Logical and physical time

All events have an associated **tag**, which is used to order events on a logical timeline at runtime. In time-sensitive applications, tags are not purely used for logical ordering but also relate to physical time. By default, the runtime only processes the events associated with a certain tag once the current physical time T is greater than the time value of the tag t ($T > t$). We say that logical time “chases” physical time. The relationship between physical and logical time in the reactor model gives logical delays a useful semantics and also permits the formulation of deadlines. This timed semantics is particularly useful for software that operates in cyber-physical systems. For a more in depth discussion of LF’s timed-semantics, the interested reader may refer to [54].

If an application has no need for any physical time properties, the concurrence of physical and logical time can be turned off; in this case, the tags are used only to preserve determinism, not to control timing. Moreover, LF programmers are not required to explicitly control timing aspects of their programs. Delays can simply be omitted, for instance when scheduling an action, in which case the runtime will use the next available tag. In consequence, also untimed general purpose programs can benefit from the deterministic concurrency enabled by LF’s timed-semantics.

3.3 Asynchrony and deliberate nondeterminism

The reactor model distinguishes logical actions and *physical* ones. A logical action is always scheduled synchronously with a delay relative to the current tag. A **physical action** may be scheduled from asynchronous contexts; its event is assigned a logical time based on the current reading of physical time. Physical actions are the key mechanism for handling sporadic inputs originating from physical processes (such as users initiating withdrawal or deposit requests).

The assignment of tags to physical actions is nondeterministic in the sense that it is not defined by the program.

However, once those tags are assigned, for example, to deposit or withdrawal requests by a user, the processing of the events is deterministic and occurs in tag order. Hence, the tags assigned to externally initiated events are considered as part of the *input*, and given this input, the program remains deterministic. This approach draws a clear perimeter around the deterministic and therefore testable program logic while allowing it to interact with sporadic external inputs.

Physical actions can also be used within the program itself, for example, to nondeterministically assign a new tag to a message received from another reactor. In this usage, physical actions provide a means for deliberately introducing actor-like nondeterminism into a program.

4 Efficient Deterministic Concurrency

LF programs are deterministic by default. This property is inherited from the reactor model that LF implements. Lohstroh et al. [53] explain why reactors behave deterministically. Their argument can be adapted to the concrete context of the LINGUA FRANCA language, but this is beyond the scope of this paper. Reactors are also concurrent, and, as we show in this paper, the exposed concurrency is sufficient for the runtime system to effectively exploit multi-core hardware to where it matches or exceeds the performance of fundamentally asynchronous and nondeterministic actor frameworks. In this section, we first show exactly how concurrency is exposed and then describe in more depth how our C++ runtime is implemented and how it utilizes parallel hardware.

4.1 Parallelism

The use of statically declared ports and connections as the interfaces between reactors, as well as the declarations of reaction dependencies, distinguish reactors from more dynamic models like actors or other asynchronous message passing frameworks where communication is purely based on addresses. While the fixed topology of reactor programs is less flexible and limits runtime adaptation, it also provides two key advantages. First, it achieves a separation of concerns between the functionality of components and their composition. Second, it makes explicit at the interface level which dependencies exist between components. As a consequence, a dependency graph can be derived for any composition of reactors. The dependency graph is an **acyclic precedence graph (APG)** that organizes all reactions into a partial order that captures all scheduling constraints that must be observed to ensure that the execution of a reactor program yields deterministic results. Because this graph is valid irrespective of the contents of the code that executes when reactions are triggered, reactions can be treated as a black box. It is this property that enables the polyglot nature of LF and exposes the concurrency in the application.

Figure 3 shows the dependency graph for the program given in Figure 2c. The solid arrows represent dependencies

that arise because one reaction (possibly) sends data to the other. The dashed arrows represent dependencies that arise because the two reactions belong to the same reactor. Analogous to the behaviors of actors, reactions of the same reactor are mutually exclusive. The execution order is well-defined and given by the lexical declaration order of the reactions in LF code. This order is also indicated by the numbers in the reaction labels in Figure 2.

The dependency graph precisely defines in which order reactions need to be executed. Independent reactions may be executed in parallel without breaking determinism. For instance, the APG in Figure 3 tells us that reaction 1 of ProxyDelay and the reactions of userA and userB can all execute in parallel. Note that the dependency graph is required to be acyclic as any cycle would violate causality. The LF compiler ensures that a valid program has an acyclic dependency graph. Any dependency cycles in LF programs can be resolved by introducing a logical action and using it to schedule a new event at a future tag.

Since in LF all dependencies are statically declared, there is a lack of runtime agility compared to actors and similar models. The reactor model compensates this with **mutations** that support runtime adaptations of the reactor topology and the implied dependency graph. However, LF does not fully implement mutations yet and a discussion of mutations is beyond the scope of this paper.

4.2 Scalable Connection Patterns

Creating individual reactor instances, ports and connections becomes tedious for larger programs. To address this problem, we introduce an extension to the LF syntax that allows to create multiple ports or reactor instances at once. Further, we introduce an overloading of LF's connection operator to create multiple connections over multiports and banks at once. This mechanism allows realizing various complex connection patterns in a single line of code and, as it is fully parameterizable, allows LF programs to transparently scale to a given problem size without recompiling.

Consider a simple fork-join program in LF:¹

```

1 reactor Src(w: int(3)) {
2   output[w] out: int
3 }
4 reactor Worker {
5   input in: int
6   output out: int
7 }
8 reactor Sink(w: int(3)) {
9   input[w] in: int
10 }
11 main reactor(w: int(3)) {
12   src = new Src(w = w)
13   dst = new Sink(w = w)
14   wrk = new[w] Worker()
15   src.out -> wrk.in
16   wrk.out -> dst.in
17 }

```

The program defines a Src, a Worker, and a Sink reactor and an unnamed main reactor that assembles the program. Worker defines two individual ports of type int called in and out. Src

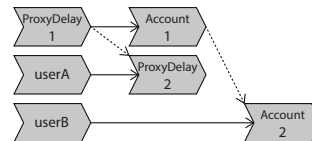

Figure 3. Reaction graph for the program in Figure 2c.

and Sink use our syntax extension to each define a **multiport** of width w , where w is a parameter and defaults to 3. The main reactor creates all reactor instances and connections. Concretely, it creates two individual instances of Src and Sink and uses our syntax extension to create a **bank** of worker reactors of width w (line 14). The two connection statements (line 15, 16) establish w connections each, one for each pair of multiport and bank instance. The resulting connection pattern is illustrated in Figure 4a. Note that the precise number of workers is configurable via the w parameter of the main reactor, which can be specified when executing the program without recompiling. Hence the program can be configured to an arbitrary number of workers.

In this example, the source reactor produces three separate values to be sent to the worker. Instead, if we want to broadcast a single value to all workers, then we can use the broadcast syntax $(...)+$. Configuring the source reactor to use a single output (by setting $w=1$ in line 12) and changing line 15 to $(src.out)+ \rightarrow wrk.in$ creates the pattern in Figure 4b.

Another common pattern that can be conveniently expressed using LF syntax is a cascade composition, illustrated by the following program:

```

1 main reactor(n: int(2)) {
2   src = new Src(w = 1)
3   dst = new Sink(w = 1)
4   wrk = new[n] Worker()
5   src.out, wrk.out -> wrk.in, dst.in
6 }

```

The connection operator sequences all ports listed on the left- and right-hand side, and connects the n th port on the left hand side to the n th port on the right-hand side. By offsetting the left-hand side of the connection statement in line 5 with a single source port and appending the sink port to the right hand side, we can effectively arrange the connections to form the cascade shown in Figure 4c.

The connection operator also connects multiports within banks. In this case, the operator will implicitly unfold all port instances on both sides of the connection to form a flat list of ports. The unfolding happens such that we first list all ports of the first bank instance, then all ports of the second instance, and so on. Consider the following program:

```

1 reactor Node(w: int(3)) {
2   input[w] in: int
3   output[w] out: int
4 }
5 main reactor(w: int(3)) {
6   node = new[w] Node(w=w)
7   node.out -> node.in
8 }

```

This will create the pattern shown in Fig. 4d which is not very useful. Using the `interleaved` modifier on either side of the connection in line 7, we can modify the unfolding

¹Implementation details are omitted for brevity. Please refer to [53] for an introduction to LF syntax.

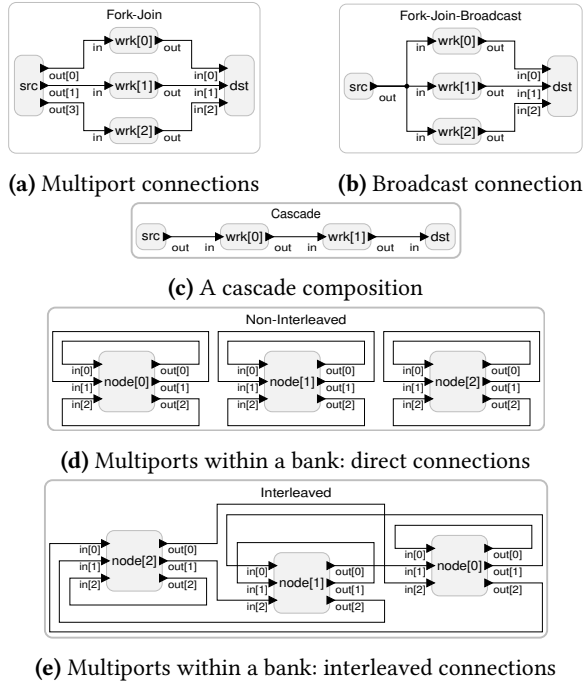

Figure 4. Various connection patterns in LINGUA FRANCA

strategy to first list all first port instances within all bank instances, then the second port instances within all bank instances, and so on. This creates the fully connected pattern shown in Figure 4e.

All of the patterns discussed in this section are used extensively in our benchmark implementations in Section 5.

4.3 Runtime Implementation

The execution of each LF program is governed by a runtime. Most importantly, the runtime includes a scheduler which keeps track of all scheduled future events, controls the advancement of logical time, and invokes any triggered reactions in the order specified by the dependency graph while aiming to exploit as much parallelism as possible. Lohstroh et al. have already sketched a simple scheduling algorithm for reactor programs [51]. In this section, we present a C++ implementation of this scheduling algorithm that aims at exploiting parallelism while keeping synchronization overhead to a minimum and avoiding contention on shared resources.

Figure 5 gives an overview of the scheduling mechanism used in our runtime. The scheduler keeps track of future events in the *event queue* and processes them strictly in tag order. When processing an event, the scheduler first determines all reactions that are triggered by the event and stores them in the *reaction queue*. Any reactions in the reaction queue for which all dependencies are met (as indicated by the APG) are forwarded to the ready queue and then picked up for execution by the worker threads. If the executed reactions trigger any further reactions by setting ports, those reactions are inserted in the reaction queue. If a reaction

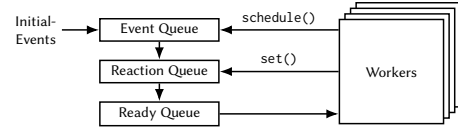

Figure 5. Scheduling mechanism in the LF runtime.

schedules future events via an action, these new events are inserted into the event queue. Note that the scheduler always waits until all reactions at the current tag are processed before advancing to the next tag and triggering new reactions.

The most important task of the scheduler is to decide when any given reaction should be moved from the reaction queue to the ready queue. As the APG precisely defines the ordering constraints of reactions, reaction scheduling is closely related to DAG-based scheduling strategies [2, 38]. However, the APG is not equivalent to a task graph as it may contain reactions that do not need to be executed. Most often only a fraction of the reactions is triggered at a particular tag. Moreover, we do not know in advance precisely which reactions will be triggered for a given tag, as reactions may or may not send messages via their declared ports. In consequence an optimal schedule cannot be computed in advance.

To decide whether a given triggered reaction is ready for execution, we need to check if it has a dependency on any other reaction that is triggered or currently executing. To avoid traversing the APG at runtime, we utilize a simple heuristic. Concretely, we assign a *level* (top level as defined in [38]) to each reaction. Any reactions with the same level do not depend on each other and hence can be executed in parallel. Our scheduler then processes reactions going from one level to the next. Once all reactions within a level are processed, all triggered reactions in the next level are moved to the ready queue. This approach avoids the need for analyzing the APG during execution, but also falls short on exploiting all opportunities for parallel execution. For instance, this approach does not execute reaction 2 of `ProxyDelay` in parallel with reaction 2 of `Account`. Nonetheless, our evaluation shows that this strategy is sufficient to efficiently exploit parallelism in most cases. Given the extensive research on DAG-scheduling, we are confident that we can apply more complex strategies in future work to also account for the missed opportunities for exploiting parallelism.

Another limitation of our scheduling approach is that the scheduler only executes reactions that are triggered at the same tag. In particular, this may hinder exploiting pipeline parallelism in programs that do not use logical delays to create separate pipeline stages. However, this limitation can be overcome by using a federated execution strategy as discussed by Bateni et al. [7].

While the scheduling algorithm sketched in [51] and refined in this section is relatively straight forward to implement, further optimizations were needed to achieve competitive performance. In the following, we detail the most important optimizations that we use in our C++ runtime.

Coordinating worker threads. In the above discussion we conceptually distinguished the scheduler from the workers. In an actual implementation, however, using a central scheduler and separate worker thread imposes a significant synchronization overhead. Instead, in our implementation, any of the worker threads can become the scheduler and move ready reactions to the ready queue or advance logical time to the next tag if all reactions have been processed. Furthermore, we exploit the fact that at any time we know the number of reactions to execute in parallel and use a counting semaphore to control the number of active workers.

Lock-free data structures. The three queues and other data structures that are required for bookkeeping (e.g., a list of all set ports) are shared across workers. Using mutexes for synchronization proved to be inefficient due to high contention on the shared resources, especially when many parallel reactions set ports or schedule actions. Instead, we utilize lock-free data structures where possible. For instance, the ready queue is implemented as a fixed size buffer paired with an atomic counter. Since we know precisely how many reactions can at most run in parallel (i.e. the maximum number of reactions in the APG that have the same level), we can fix the size of the queue. Every time new reactions are moved to the reaction queue, the atomic counter is set to the number of reactions in the queue. Each time a worker tries to execute a reaction it atomically decrements the counter. If the result is negative, then the queue is empty. Otherwise the result provides the index within the buffer to read from.

We further exploit knowledge about the execution of reactor programs. For instance, the scheduler advances logical time only once all reactions have been processed. This operation is safe without additional synchronization, as all of the workers are waiting for new reactions.

Sparse multiports. In programs where reactions in multiple reactors may trigger the same reaction (such as an account with an arbitrary number of users), the triggered reaction often needs to know which port(s) actually are set (contain data). If there are many upstream reactors and communication is sparse, simply checking all ports for presence can be inefficient. Instead, we expose an API for obtaining an iterator to only set ports. Note that this problem does not arise in actors, as no ports exist and messages are processed one by one, only considering those that are actually sent.

5 Performance evaluation

The actor model is widely accepted for programming large concurrent applications, and implementations such as the C++ Actor Framework (CAF) [16] and Akka [66] are known to be fast and efficient in utilizing a larger number of threads. Compared to actors, LF imposes various restrictions that amount to a model of computation in which fewer behaviors are allowed. In this section, we show that these restrictions

do not necessarily introduce overhead or higher execution times. In fact, LF is considerably faster for many benchmarks.

5.1 Methodology

Our evaluation is based on the Savina benchmark suite [34] for actor languages and frameworks. While this suite has several issues, as Blessing et al. discuss in [13], Savina covers a wide range of patterns and, to the best of our knowledge, is the most comprehensive benchmark suite for actor frameworks that has been published. The Savina suite includes Akka implementations of all benchmarks. CAF implementations of most Savina benchmarks are also available.²

We ported 22 of the 30 Savina benchmarks to the C++ target of LF.³ Due to the fundamental differences between the actor and reactor model, the process of porting benchmarks is not always straightforward. We aimed at closely resembling the original workloads and considered the intention behind the individual benchmarks. We did not implement the benchmarks Fork Join (actor creation), Fibonacci, Quicksort, Bitonic Sort, Sieve of Eratosthenes, Unbalanced Cobwebbed Tree, Online Facility Location, and Successive Over-Relaxation as they require the capability to dynamically create actors. In the reactor model, this can be achieved with mutations that may modify the reactor topology [50, 51]. However, mutations are not yet fully implemented in LF, and a discussion of language-level constructs for supporting mutations is beyond the scope of this paper.

We further omit the A*-Search and Logistic Map Series benchmarks from our presentation. A*-Search suffers from a severe race condition that results in wildly varying execution times [13]. Logistic Map Series is omitted as it violates actor semantics and requires explicit synchronization [13]. For this reason, the CAF implementation needs to use a blocking call, which makes it slower than the other implementations by at least two orders of magnitude. Since this is not a problem of CAF, but rather a problem in the benchmark design, we omit Logistic Map Series to avoid skewing the analysis.

Figure 6 reports measured results for all supported benchmarks obtained with Akka, CAF, and the C++ target of LF. The plots show the mean execution times (including 99% confidence intervals) for a varying number of worker threads for each of the benchmarks. Not all benchmarks are implemented in CAF and hence it is missing in some plots.

All measurements were performed on a workstation with an Intel Core i9-10900K processor with 32 GiB DDR4-2933 RAM running Ubuntu 22.04 and using CAF version 17.6 and Akka version 2.6.17. Following the methodology of Savina, measurements exclude initialization and cleanup. Each measurement comprises 32 iterations. The first two iterations are

²<https://github.com/woelke/savina>

³Source code available at <https://github.com/lf-lang/benchmarks-lingua-franca>

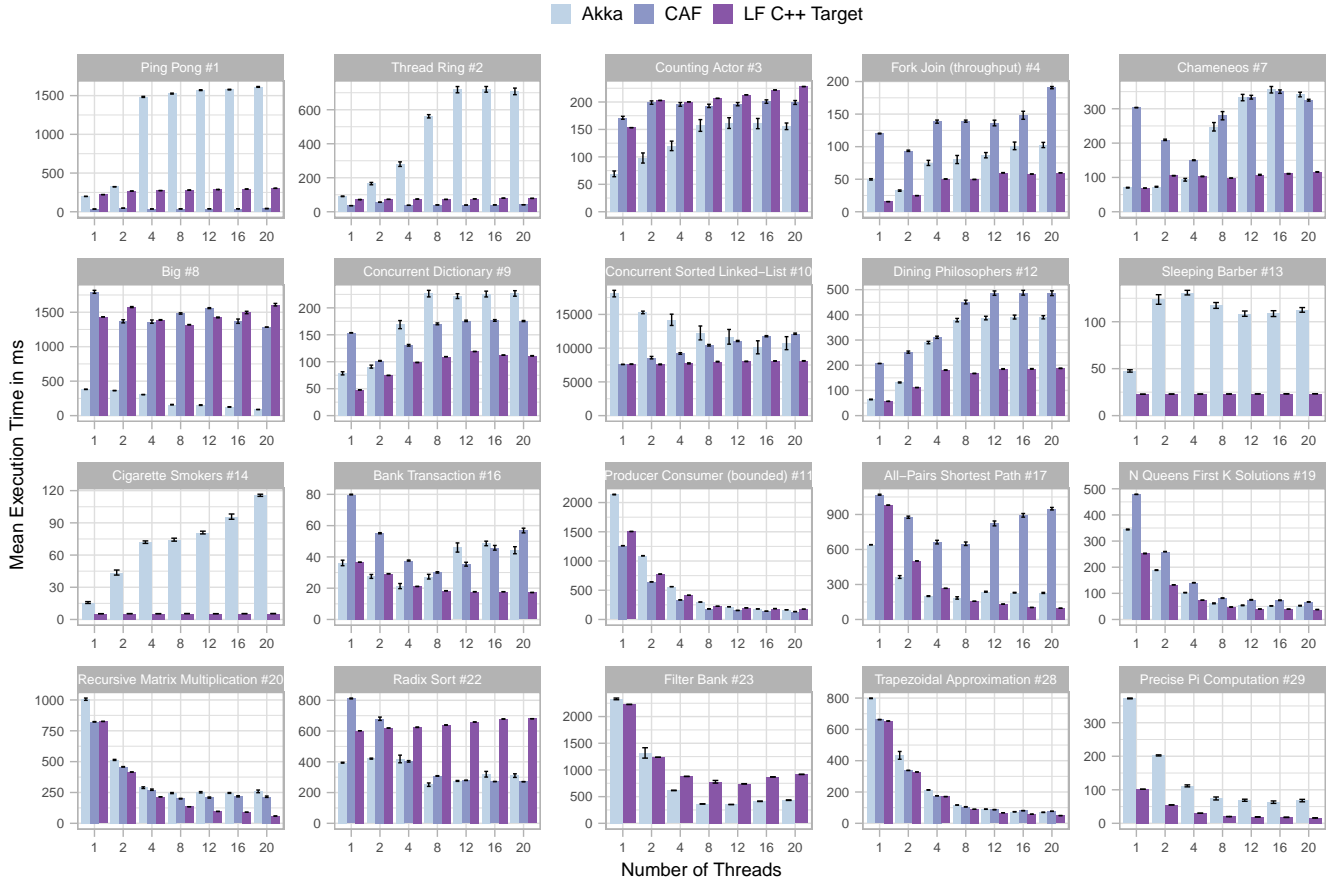

Figure 6. Mean execution times and 99% confidence intervals for various Savina benchmarks implemented in LF, CAF, and Akka, measured for a varying number of worker threads. The numbers prefixed with # are benchmark IDs as listed in [34].

excluded from our analysis and are used to warm up caches and the JVM (in the case of Akka).

5.2 Discussion

The first six plots in Figure 6 belong to the group of micro benchmarks in the Savina suite. These are designed to expose overhead in the protocol used for exchanging messages and for scheduling. Overall, our C++ runtime shows comparable performance to Akka and CAF. In Ping Pong and Thread Ring, our implementation is considerably faster than Akka but is still outperformed by CAF. For Counting Actor and Big, Akka performs better and the LF performance is slightly behind CAF. In Fork Join and Chameneos, the LF implementation outperforms both Akka and CAF, especially when using a larger number of worker threads.

The next six plots (Concurrent Dictionary to Bank Transaction) belong to the group of concurrency benchmarks. LF significantly outperforms CAF and Akka in all the concurrency benchmarks (especially for a high number of worker threads). This highlights how concurrent behavior is expressed naturally in LF and can be executed efficiently. Actor implementations of those benchmarks, on the other hand,

have to synchronize explicitly and resort to potentially expensive protocols (e.g., by sending acknowledge messages), or implement some other (blocking) synchronization strategy that violates actor semantics [13].

The remaining plots belong to the group of parallelism benchmarks in the Savina suite⁴. Radix Sort and Filter Bank suffer somewhat from an inefficiency in our scheduler, as discussed in Section 4.3. In these particular benchmarks, our simple algorithm leads to a non-optimal execution as some reactions are executed later than they could. We will revise this algorithm in future work. However, the remaining parallelism benchmarks highlight that LF can efficiently implement parallel algorithms. Our LF implementations are on par with Akka and CAF and scale well with more threads.

On average, LF outperforms both Akka and CAF. For 20 threads, the C++ runtime achieves a speedup of 1.85x over Akka and a 1.42x speedup over CAF. These speedups were calculated using the geometric mean over the speedups of individual benchmarks. We conclude that LF can compete with and even outperform modern and highly optimized

⁴Producer Consumer is actually listed as a concurrency benchmark, but we find it fits better to the group of parallelism benchmarks.

actor frameworks such as Akka and CAF. Particularly with workloads that require synchronization, LF significantly outperforms actor implementations. LF is as efficient as the actor frameworks in exploiting parallelism and scales well to a larger thread count. In summary, the deterministic concurrency provided by LF does not hinder performance but enables more efficient implementations. This is possible in part because the scheduler has insights into the program structure, and explicit synchronization can be avoided in LF, as opposed to many of Savina actor benchmarks.

The performance comparison between C++ and Scala (Akka) needs to be taken with care, as other factors such as different library implementations and the behavior of the JVM may influence performance. For instance, the large discrepancy between Akka and our implementation in the Pi Precision benchmark is explained by a less efficient representation of large numbers in Scala/Java. However, the other benchmarks of the Savina suite do not depend on external libraries and are designed to be more portable between languages. Also note that over all benchmarks CAF only achieves an average speedup of 1.09x over Akka for 20 threads and is outperformed in 9 out of 16 benchmarks. For single threaded execution, Akka outperforms CAF in 10 benchmarks and achieves an average speedup of 1.33x. This indicates that the implemented Scala workloads are comparable to the C++ implementations. Even considering a potential skew due to the JVM, our results clearly show that LF can compete with state-of-the-art actor frameworks.

To better understand the impact of the optimizations discussed in Section 4.3, Figure 7 also shows the speedup of our runtime for 20 worker threads compared to a less optimized runtime. This baseline is an older version of our runtime that is optimized in the sense that we used code profiling to identify obvious bottlenecks and eliminated them using common code optimization techniques, but that does not include the optimizations discussed in this paper. The average overall speedup (geometric mean) achieved by our optimizations is 2.18x. In particular, Big and Bank Transaction significantly benefit from our optimization for sparse communication patterns. The concurrency benchmarks (e.g., Concurrent Dictionary and Dining Philosophers), are mostly improved by reducing the contention on shared resources. However, not all benchmarks benefit from our optimizations. The reduced performance in Ping Pong and Counting Actor shows that optimizing for efficient parallel execution also comes at a cost for simple sequential programs.

6 Related Work

LF is closely related to the languages and frameworks evolved around Hewitt’s actor model [1, 33], including Akka [66], CAF [16], Ray [60], Erlang [3], Rebeca [70], P [22] and Pony [17]. Also reactive programming techniques [5], as used in frameworks like ReactiveX [56] and Reactors.IO [65] but

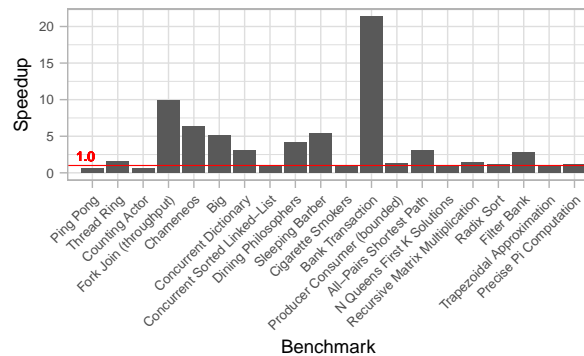

Figure 7. Speedup achieved by our optimized C++ runtime for 20 worker threads compared to an unoptimized version.

also in language-level constructs like event loops [74], are closely related to LF. While actors and reactive programming provide good resiliency and scalability, this comes at the cost of nondeterminism, which makes programs notoriously hard to test and debug [6, 75]. Even more problems arise if languages, frameworks, and libraries do not enforce the underlying model and invite the programmer to break its semantics [71]. Pony addresses the later problem by leveraging a strong type system similar to Rust to prevent data races at compile time. Rebeca provides a formalism and model checking techniques for analyzing and verifying actor networks. While this can improve confidence in a correct implementation, the programmer is still responsible for finding this correct implementation. P goes a step further in that it also has an efficient runtime system and a compiler that generates correct-by-construction code with reasonable performance.

Blessing et al. propose a strategy that maps actor communication to a tree topology in order to guarantee a causal ordering of messages [12]. In a similar approach, Sang et al. utilize a DAG topology to achieve serializability in the processing of events. Orleans [14] is also based on an actor-like model and provides guarantees on atomicity on transactions. Finally, Reactors as defined by Field et al. [28] is a model that is closely related to actors but that supports both synchronous and asynchronous communication and also provides atomicity guarantees. All these strategies are most useful in distributed scenarios, in particular in presence of network failures. In this paper, however, we focus on the execution of a single host. Moreover, the determinism guarantees that LF makes are stronger. Nonetheless, such techniques are highly relevant to LF and could be deployed for ensuring fault-tolerant execution in distributed LF programs. We believe, however, that LF provides a more general solution, as the programmer can explicitly trade consistency for availability in distributed contexts [42], and hence the solution can be adjusted to the concrete application requirements.

Dataflow models [11, 21, 44] and process networks [35, 45] provide deterministic concurrency by creating statically connected networks of actors with deterministic semantics.

These models enable improved static analysis and optimization [30], but they limit the application’s flexibility and capability to react to external events. Ohua [26] is another language providing parallelism through dataflow and is similar to LF in that it integrates with existing high-level languages. However, it falls short on exposing coordination facilities for individual nodes and does not provide a timed semantics.

Deterministic concurrency is also found in synchronous languages such as Esterel [10], Lustre [31], and SIGNAL [9] as well as in Functional Reactive Programming (FRP) languages, like Fran [25], FrTime [19], and Elm [20]. However, these languages are challenging to use for general purpose programming as they require pure functions and there is a lack of widely-applicable libraries. Only recently, side effects have been considered in a formal semantics for Esterel [29] and distributed dataflow [59]. In LINGUA FRANCA, arbitrary code can be embedded in reactions and we can benefit from the available libraries for popular general purpose languages.

Another interesting approach is taken by deterministic multithreading libraries such as DThreads [49] or Consequence [57], which enforce a total order for concurrent store operations. Recent work has made considerable progress in avoiding the bottlenecks of conventional DTM techniques [58]. However, we argue that threads are not a convenient concurrency model for the reasons outlined in [40]. Moreover, threads do not allow for transparent distributed execution as is possible with (re)actors.

7 Conclusion

Unlike actors and related models for asynchronous concurrency, LF enforces determinism by default, and features asynchronous behavior only when introduced deliberately. Our evaluation, based on LF’s C++ target, shows that this deterministic model does not impede performance. On the contrary, we achieve an average speedup of 1.85x over Akka and 1.42x over CAF. With LF, we manage to combine reproducible (and testable) behavior with good performance. Yet, our relatively simple scheduling strategy likely still leaves room for significant improvement. We leave it as future work to explore more advanced scheduling algorithms capable of exploiting more parallelism at runtime. We also aim to furnish full runtime support for mutations and implement the remaining Savina benchmarks that require them. Finally, we note that our implementation of the Savina benchmark suite is not only useful for comparing LF to actor-oriented frameworks; it also demonstrates that LF, which is still in its infancy, is already suitable for solving practical problems.

Acknowledgments

The work in this paper was supported in part by the German Federal Ministry of Education and Research (BMBF) as part of the Software Campus (01IS12051) and the program “Souverän. Digital. Vernetzt.”, joint project 6G-life (16KISK001K).

This work was also supported in part by the National Science Foundation (NSF), award #CNS-1836601 (Reconciling Safety with the Internet), the iCyPhy Research Center (Industrial Cyber-Physical Systems), supported by Denso, Ford, Siemens, and Toyota, and the National Research Foundation (NRF) of Korea (No. NRF-2022R1F1A1065201).

References

- [1] Gul A. Agha, Ian A. Mason, Scott F. Smith, and Carolyn L. Talcott. 1997. A foundation for actor computation. *Journal of Functional Programming* 7, 1 (1997), 1–72.
- [2] Mahfooz Alam, As If, and Ankur Varshney. 2018. *A Review of Dynamic Scheduling Algorithms for Homogeneous and Heterogeneous Systems*. 73–83. <https://doi.org/10.1007/978-981-10-8533-8>
- [3] Joe Armstrong, Robert Virding, Claes Wikström, and Mike Williams. 1996. *Concurrent programming in Erlang* (second ed.). Prentice Hall.
- [4] Mehdi Bagherzadeh, Nicholas Fireman, Anas Shawesh, and Raffi Khatchadourian. 2020. Actor Concurrency Bugs: A Comprehensive Study on Symptoms, Root Causes, API Usages, and Differences. *Proc. ACM Program. Lang.* 4, OOPSLA, Article 214 (nov 2020), 32 pages. <https://doi.org/10.1145/3428282>
- [5] Engineer Bainomugisha, Andoni Lombide Carreton, Tom van Cutsem, Stijn Mostinckx, and Wolfgang Meuter. 2013. A Survey on Reactive Programming. *ACM Comput. Surv.* 45, 4, Article 52 (Aug. 2013), 34 pages. <https://doi.org/10.1145/2501654.2501666>
- [6] Herman Banken, Erik Meijer, and Georgios Gousios. 2018. Debugging data flows in reactive programs. In *2018 IEEE/ACM 40th International Conference on Software Engineering (ICSE)*. IEEE, 752–763.
- [7] Soroush Bateni, Marten Lohstroh, Hou Seng Wong, Rohan Tabish, Hokeun Kim, Shaokai Lin, Christian Menard, Cong Liu, and Edward A. Lee. 2022. Xronos: Predictable Coordination for Safety-Critical Distributed Embedded Systems. <https://doi.org/10.48550/ARXIV.2207.09555>
- [8] Albert Benveniste and Gérard Berry. 1991. The Synchronous Approach to Reactive and Real-Time Systems. *Proc. IEEE* 79, 9 (1991), 1270–1282.
- [9] Albert Benveniste and Paul Le Guernic. 1990. Hybrid Dynamical Systems Theory and the SIGNAL Language. *IEEE Tr. on Automatic Control* 35, 5 (1990), 525–546.
- [10] Gérard Berry and Georges Gonthier. 1992. The Esterel synchronous programming language: Design, semantics, implementation. *Science of Computer Programming* 19, 2 (1992), 87–152. <http://citeseerx.ist.psu.edu/viewdoc/summary?doi=10.1.1.17.5606>
- [11] G. Bilsen, M. Engels, R. Lauwereins, and J. A. Peperstraete. 1994. Static Scheduling of Multi-rate and Cyclo-Static DSP Applications. In *Workshop on VLSI Signal Processing*. IEEE Press.
- [12] Sebastian Blessing, Sylvan Clebsch, and Sophia Drossopoulou. 2017. Tree Topologies for Causal Message Delivery. In *Proceedings of the 7th ACM SIGPLAN International Workshop on Programming Based on Actors, Agents, and Decentralized Control (Vancouver, BC, Canada) (AGERE 2017)*. Association for Computing Machinery, New York, NY, USA, 1–10. <https://doi.org/10.1145/3141834.3141835>
- [13] Sebastian Blessing, Kiko Fernandez-Reyes, Albert Mingkun Yang, Sophia Drossopoulou, and Tobias Wrigstad. 2019. Run, Actor, Run: Towards Cross-Actor Language Benchmarking. In *Proceedings of the 9th ACM SIGPLAN International Workshop on Programming Based on Actors, Agents, and Decentralized Control (Athens, Greece) (AGERE 2019)*. Association for Computing Machinery, New York, NY, USA, 41–50. <https://doi.org/10.1145/3358499.3361224>
- [14] Sergey Bykov, Alan Geller, Gabriel Kliot, James R. Larus, Ravi Pandya, and Jorgen Thelin. 2011. Orleans: Cloud Computing for Everyone. In *Proceedings of the 2nd ACM Symposium on Cloud Computing (Cascais, Portugal) (SOCC ’11)*. Association for Computing Machinery, New York, NY, USA, Article 16, 14 pages. <https://doi.org/10.1145/2038916>

2038932

- [15] C. G. Cassandras. 1993. *Discrete Event Systems, Modeling and Performance Analysis*. Irwin.
- [16] Dominik Charousset, Raphael Hiesgen, and Thomas C. Schmidt. 2016. Revisiting Actor Programming in C++. *Computer Languages, Systems & Structures* 45 (April 2016), 105–131.
- [17] Sylvan Clebsch, Juliana Franco, Sophia Drossopoulou, Albert Mingkun Yang, Tobias Wrigstad, and Jan Vitek. 2017. Orca: GC and Type System Co-Design for Actor Languages. *Proc. ACM Program. Lang.* 1, OOPSLA, Article 72 (oct 2017), 28 pages. <https://doi.org/10.1145/3133896>
- [18] Eric C Cooper and Richard P Draves. 1988. *C threads*. Technical Report CMU-CS-88-154.
- [19] Gregory H Cooper and Shriram Krishnamurthi. 2006. Embedding dynamic dataflow in a call-by-value language. In *European Symposium on Programming*. Springer, 294–308.
- [20] Evan Czaplicki and Stephen N Chong. 2013. Asynchronous functional reactive programming for GUIs. In *Proceedings of the 34th ACM SIGPLAN Conference on Programming Language Design and Implementation-PLDI'13*. ACM Press.
- [21] Jack B. Dennis. 1974. *First Version Data Flow Procedure Language*. Report MAC TM61. MIT Laboratory for Computer Science.
- [22] Ankush Desai, Vivek Gupta, Ethan Jackson, Shaz Qadeer, Sriram Rajamani, and Damien Zufferey. 2012. *P: Safe Asynchronous Event-Driven Programming*. Report. Microsoft Research.
- [23] Stephen Edwards and John Hui. 2020. The Sparse Synchronous Model. In *Forum for Specification and Design Languages (FDL)*, Kiel, Germany, Sep. 15–17. IEEE, 1–8.
- [24] Stephen A. Edwards and Edward A. Lee. 2003. The Semantics and Execution of a Synchronous Block-Diagram Language. *Science of Computer Programming* 48, 1 (2003), 21–42. [https://doi.org/10.1016/S0167-6423\(02\)00096-5](https://doi.org/10.1016/S0167-6423(02)00096-5)
- [25] Conal Elliott and Paul Hudak. 1997. Functional reactive animation. In *ACM SIGPLAN Notices*, Vol. 32. ACM, 263–273.
- [26] Sebastian Ertel, Justus Adam, and Jeronimo Castrillon. 2018. Supporting fine-grained dataflow parallelism in big data systems. In *Proceedings of the 9th International Workshop on Programming Models and Applications for Multicores and Manycores*. 41–50.
- [27] Patrick Th. Eugster, Pascal A. Felber, Rachid Gerraoui, and Anne-Marie Kermarrec. 2003. The Many Faces of Publish/Subscribe. *Comput. Surveys* 35, 2 (2003), 114–131. <https://doi.org/10.1145/857076.857078>
- [28] John Field, Maria-Cristina Marinescu, and Christian Stefansen. 2009. Reactors: A data-oriented synchronous/asynchronous programming model for distributed applications. *Theoretical Computer Science* 410, 2 (2009), 168–201. <https://doi.org/10.1016/j.tcs.2008.09.052> Distributed Computing Techniques.
- [29] Spencer P Florence, Shu-Hung You, Jesse A Tov, and Robert Bruce Findler. 2019. A calculus for Esterel: if can, can. if no can, no can. *Proceedings of the ACM on Programming Languages* 3, POPL (2019), 1–29.
- [30] Marc Geilen, Twan Basten, and Sander Stuijk. 2005. Minimising Buffer Requirements of Synchronous Dataflow Graphs with Model Checking. In *Design Automation Conference (DAC)*. ACM, 819–824. <https://doi.org/10.1145/1065579.1065796>
- [31] Nicholas Halbwachs, Paul Caspi, Pascal Raymond, and Daniel Pilaud. 1991. The synchronous data flow programming language LUSTRE. *Proc. IEEE* 79, 9 (1991), 1305–1320.
- [32] Brandon Hedden and Xinghui Zhao. 2018. A Comprehensive Study on Bugs in Actor Systems. In *Proceedings of the 47th International Conference on Parallel Processing (Eugene, OR, USA) (ICPP 2018)*. Association for Computing Machinery, New York, NY, USA, Article 56, 9 pages. <https://doi.org/10.1145/3225058.3225139>
- [33] Carl Hewitt. 2010. Actor model of computation: scalable robust information systems. *arXiv preprint arXiv:1008.1459* (2010).
- [34] Shams M. Imam and Vivek Sarkar. 2014. Savina - An Actor Benchmark Suite: Enabling Empirical Evaluation of Actor Libraries. In *Proceedings of the 4th International Workshop on Programming Based on Actors Agents & Decentralized Control (Portland, Oregon, USA) (AGERE! '14)*. Association for Computing Machinery, New York, NY, USA, 67–80. <https://doi.org/10.1145/2687357.2687368>
- [35] Gilles Kahn. 1974. The Semantics of a Simple Language for Parallel Programming. In *Proc. of the IFIP Congress 74*. North-Holland Publishing Co., 471–475.
- [36] Gilles Kahn and D. B. MacQueen. 1977. Coroutines and Networks of Parallel Processes. In *Information Processing*, B. Gilchrist (Ed.). North-Holland Publishing Co., 993–998.
- [37] Dieter Kranzlmüller and Martin Schulz. 2002. Notes on Nondeterminism in Message Passing Programs. In *Recent Advances in Parallel Virtual Machine and Message Passing Interface*, Dieter Kranzlmüller, Jens Volkert, Peter Kacsuk, and Jack Dongarra (Eds.). Springer Berlin Heidelberg, Berlin, Heidelberg, 357–367.
- [38] Yu-Kwong Kwok and Ishfaq Ahmad. 1999. Static Scheduling Algorithms for Allocating Directed Task Graphs to Multiprocessors. *ACM Comput. Surv.* 31, 4 (dec 1999), 406–471. <https://doi.org/10.1145/344588.344618>
- [39] Ivan Lanese, Naoki Nishida, Adrián Palacios, and Germán Vidal. 2018. CauDER: A Causal-Consistent Reversible Debugger for Erlang. In *Functional and Logic Programming*, John P. Gallagher and Martin Sulzmann (Eds.). Springer International Publishing, Cham, 247–263.
- [40] Edward A. Lee. 2006. The Problem with Threads. *Computer* 39, 5 (2006), 33–42. <https://doi.org/10.1109/MC.2006.180>
- [41] Edward A. Lee. 2021. Determinism. *ACM Transactions on Embedded Computing Systems (TECS)* 20, 5 (July 2021), 1–34. <https://doi.org/10.1145/3453652>
- [42] Edward A. Lee, Soroush Bateni, Shaokai Lin, Marten Lohstroh, and Christian Menard. 2021. Quantifying and Generalizing the CAP Theorem. *CoRR* abs/2109.07771 (2021). arXiv:2109.07771 <https://arxiv.org/abs/2109.07771>
- [43] Edward A. Lee and Eleftherios Matsikoudis. 2009. *The Semantics of Dataflow with Firing*. Cambridge University Press. <http://ptolemy.eecs.berkeley.edu/publications/papers/08/DataflowWithFiring/>
- [44] E. A. Lee and D. G. Messerschmitt. 1987. Synchronous Data Flow. *Proc. IEEE* 75, 9 (1987), 1235–1245. <https://doi.org/10.1109/PROC.1987.13876>
- [45] E. A. Lee and T. M. Parks. 1995. Dataflow Process Networks. *Proc. IEEE* 83, 5 (1995), 773–801. <https://doi.org/10.1109/5.381846>
- [46] Edward A. Lee and Haiyang Zheng. 2007. Leveraging Synchronous Language Principles for Heterogeneous Modeling and Design of Embedded Systems. In *EMSOFT*. ACM, 114 – 123. <https://doi.org/10.1145/1289927.1289949>
- [47] Edward A. Lee, Haiyang Zheng, and Ye Zhou. 2005. Causality Interfaces and Compositional Causality Analysis. In *Foundations of Interface Technologies (FIT), Satellite to CONCUR*.
- [48] Bozhen Liu, Peiming Liu, Yanze Li, Chia-Che Tsai, Dilma Da Silva, and Jeff Huang. 2021. When Threads Meet Events: Efficient and Precise Static Race Detection with Origins. In *Proceedings of the 42nd ACM SIGPLAN International Conference on Programming Language Design and Implementation*. Association for Computing Machinery, New York, NY, USA. <https://doi.org/10.1145/3453483.3454073>
- [49] Tongping Liu, Charlie Curtsinger, and Emery D. Berger. 2011. Dthreads: Efficient Deterministic Multithreading. In *Proceedings of the Twenty-Third ACM Symposium on Operating Systems Principles (Cascais, Portugal) (SOSP '11)*. Association for Computing Machinery, New York, NY, USA, 327–336. <https://doi.org/10.1145/2043556.2043587>
- [50] Marten Lohstroh. 2020. *Reactors: A Deterministic Model of Concurrent Computation for Reactive Systems*. Ph. D. Dissertation. EECS Department, University of California, Berkeley. <http://www2.eecs.berkeley.edu/Pubs/TechRpts/2020/EECS-2020-235.html>

- [51] Marten Lohstroh, Íñigo Íncar Romeo, Andrés Goens, Patricia Derler, Jeronimo Castrillon, Edward A. Lee, and Alberto Sangiovanni-Vincentelli. 2019. Reactors: A Deterministic Model for Composable Reactive Systems. In *8th International Workshop on Model-Based Design of Cyber Physical Systems (CyPhy'19)*, Vol. LNCS 11971. Springer-Verlag, 27.
- [52] Marten Lohstroh and Edward A. Lee. 2019. Deterministic Actors. In *Forum on Specification and Design Languages (FDL)*.
- [53] Marten Lohstroh, Christian Menard, Soroush Bateni, and Edward A. Lee. 2021. Toward a Lingua Franca for Deterministic Concurrent Systems. *ACM Transactions on Embedded Computing Systems (TECS), Special Issue on FDL'19 20*, 4 (May 2021), Article 36. <https://doi.org/10.1145/3448128>
- [54] Marten Lohstroh, Christian Menard, Alexander Schulz-Rosengarten, Matthew Weber, Jeronimo Castrillon, and Edward A. Lee. 2020. A Language for Deterministic Coordination Across Multiple Timelines. In *Forum for Specification and Design Languages (FDL)*. IEEE. <https://doi.org/10.1109/FDL50818.2020.9232939>
- [55] Aman Shankar Mathur, Burcu Kulahcioglu Ozkan, and Rupak Majumdar. 2018. IDEA: An Immersive Debugger for Actors. In *Proceedings of the 17th ACM SIGPLAN International Workshop on Erlang (St. Louis, MO, USA) (Erlang 2018)*. Association for Computing Machinery, New York, NY, USA, 1–12. <https://doi.org/10.1145/3239332.3242762>
- [56] Erik Meijer. 2010. Reactive Extensions (Rx): Curing Your Asynchronous Programming Blues. In *ACM SIGPLAN Commercial Users of Functional Programming (Baltimore, Maryland) (CUEFP '10)*. ACM, New York, NY, USA, Article 11, 1 pages.
- [57] Timothy Merrifield, Joseph Devietti, and Jakob Eriksson. 2015. High-Performance Determinism with Total Store Order Consistency. In *Proceedings of the Tenth European Conference on Computer Systems (Bordeaux, France) (EuroSys '15)*. Association for Computing Machinery, New York, NY, USA, Article 31, 13 pages. <https://doi.org/10.1145/2741948.2741960>
- [58] Timothy Merrifield, Sepideh Roghanchi, Joseph Devietti, and Jakob Eriksson. 2019. Lazy Determinism for Faster Deterministic Multithreading. In *Proceedings of the Twenty-Fourth International Conference on Architectural Support for Programming Languages and Operating Systems (Providence, RI, USA) (ASPLOS '19)*. Association for Computing Machinery, New York, NY, USA, 879–891. <https://doi.org/10.1145/3297858.3304047>
- [59] Ragnar Mogk, Joscha Drechsler, Guido Salvaneschi, and Mira Mezini. 2019. A fault-tolerant programming model for distributed interactive applications. *Proceedings of the ACM on Programming Languages OOPSLA (2019)*, 1–29.
- [60] Philipp Moritz, Robert Nishihara, Stephanie Wang, Alexey Tumanov, Richard Liaw, Eric Liang, William Paul, Michael I. Jordan, and Ion Stoica. 2017. Ray: A Distributed Framework for Emerging AI Applications. *CoRR abs/1712.05889 (2017)*. arXiv:1712.05889 <http://arxiv.org/abs/1712.05889>
- [61] Madanlal Musuvathi, Shaz Qadeer, Thomas Ball, Gerard Basler, Pira-manayagam Arumuga Nainar, and Iulian Neamtii. 2008. Finding and Reproducing Heisenbugs in Concurrent Programs.. In *OSDI*, Vol. 8.
- [62] Walid A. Najjar, Edward A. Lee, and Guang R. Gao. 1999. Advances in the dataflow computational model. *Parallel Comput.* 25, 13-14 (December 1999), 1907–1929.
- [63] Bruce Jay Nelson. 1981. *Remote Procedure Call*. Ph. D. Dissertation. USA.
- [64] R. Perrey and M. Lycett. 2003. Service-Oriented Architecture. In *2003 Symposium on Applications and the Internet Workshops*. IEEE, 116–119. <https://doi.org/10.1109/SAINTW.2003.1210138>
- [65] Aleksandar Prokopec. 2018. Pluggable Scheduling for the Reactor Programming Model. In *Programming with Actors: State-of-the-Art and Research Perspectives*, Alessandro Ricci and Philipp Haller (Eds.). Springer International Publishing, 125–154.
- [66] Raymond Roestenburg, Rob Bakker, and Rob Williams. 2016. *Akka In Action*. Manning Publications Co.
- [67] Koushik Sen. 2008. Race Directed Random Testing of Concurrent Programs. *SIGPLAN Not.* 43, 6 (jun 2008), 11–21. <https://doi.org/10.1145/1379022.1375584>
- [68] Lui Sha, Abdullah Al-Nayeem, Mu Sun, José Meseguer, and Pete C. Olveczky. 2009. *PALS: Physically Asynchronous Logically Synchronous Systems*. Technical Report. Univ. of Illinois. <http://hdl.handle.net/2142/11897>
- [69] Kazuhiro Shibanai and Takuo Watanabe. 2017. Actoverse: A Reversible Debugger for Actors. In *Proceedings of the 7th ACM SIGPLAN International Workshop on Programming Based on Actors, Agents, and Decentralized Control (Vancouver, BC, Canada) (AGERE 2017)*. Association for Computing Machinery, New York, NY, USA, 50–57. <https://doi.org/10.1145/3141834.3141840>
- [70] Marjan Sirjani, Ali Movaghar, Amin Shali, and Frank S. de Boer. 2004. Modeling and Verification of Reactive Systems using Rebeca. *Fundam. Inform.* 63, 4 (2004), 385–410.
- [71] Samira Tasharofi, Peter Dinges, and Ralph E Johnson. 2013. Why do scala developers mix the actor model with other concurrency models?. In *European Conference on Object-Oriented Programming*. Springer, 302–326.
- [72] Samira Tasharofi, Rajesh K. Karmani, Steven Lauterburg, Axel Legay, Darko Marinov, and Gul Agha. 2012. TransDPOR: A Novel Dynamic Partial-Order Reduction Technique for Testing Actor Programs. In *Formal Techniques for Distributed Systems*, Holger Giese and Grigore Rosu (Eds.). Springer Berlin Heidelberg, Berlin, Heidelberg, 219–234.
- [73] Samira Tasharofi, Michael Pradel, Yu Lin, and Ralph Johnson. 2013. Bit: Coverage-guided, automatic testing of actor programs. In *2013 28th IEEE/ACM International Conference on Automated Software Engineering (ASE)*. 114–124. <https://doi.org/10.1109/ASE.2013.6693072>
- [74] Stefan Tilkov and Steve Vinoski. 2010. Node.js: Using JavaScript to build high-performance network programs. *IEEE Internet Computing* 14, 6 (2010), 80–83.
- [75] Carmen Torres Lopez, Robbert Gurdeep Singh, Stefan Marr, Elisa Gonzalez Boix, and Christophe Scholliers. 2019. Multiverse Debugging: Non-Deterministic Debugging for Non-Deterministic Programs (Brave New Idea Paper). In *33rd European Conference on Object-Oriented Programming (ECOOP 2019) (Leibniz International Proceedings in Informatics (LIPIcs), Vol. 134)*, Alastair F. Donaldson (Ed.). Schloss Dagstuhl–Leibniz-Zentrum fuer Informatik, Dagstuhl, Germany, 27:1–27:30. <https://doi.org/10.4230/LIPIcs.ECOOP.2019.27>
- [76] Carmen Torres Lopez, Stefan Marr, Elisa Gonzalez Boix, and Hanspeter Mössenböck. 2018. *Programming with Actors: State-of-the-Art and Research Perspectives*. Springer International Publishing, Cham, Chapter A Study of Concurrency Bugs and Advanced Development Support for Actor-based Programs, 155–185. https://doi.org/10.1007/978-3-030-00302-9_6
- [77] Tom Van Cutsem, Elisa Gonzalez Boix, Christophe Scholliers, Anthoni Lombide Carreton, Dries Harnie, Kevin Pinte, and Wolfgang De Meuter. 2014. AmbientTalk: programming responsive mobile peer-to-peer applications with actors. *Computer Languages, Systems & Structures* 40, 3-4 (2014), 112–136.
- [78] Reinhard von Hanxleden, Edward A. Lee, Hauke Fuhrmann, Alexander Schulz-Rosengarten, Sören Domrös, Marten Lohstroh, Soroush Bateni, and Christian Menard. 2022. Pragmatics Twelve Years Later: A Report on Lingua Franca. In *Leveraging Applications of Formal Methods, Verification and Validation: Verification Principles: 11th International Symposium on Leveraging Applications of Formal Methods, ISoLA 2022*, Tiziana Margaria and Bernhard Steffen (Eds.). Springer Nature Switzerland, 60–89.
- [79] Bernard Zeigler. 1976. *Theory of Modeling and Simulation*. Wiley Interscience, New York.